

## Venerdì 3 Novembre

- dalle 14:00** Arrivo all'Hotel Ristorante I Castelli ad Alba  
Viale Torino 14 – 12051 Alba  
tel +39 0173 361978 – [www.hotel-icastelli.com](http://www.hotel-icastelli.com)
- ore 20:30** Cena al Ristorante L'Inedito – Vigin Mudest  
in Centro ad Alba: 10' a piedi dall'Hotel  
Via Vernazza 11 – 12051 Alba  
tel + 39 0173 441701 – [www.lineditoviginmudest.it](http://www.lineditoviginmudest.it)

## Sabato 4 Novembre

- ore 09:30** Partenza per la visita all'Azienda Agricola  
Barberis Bruno – Vini e Nocchie  
Strada San Lorenzo 10 – 12074 Cortemilia  
tel +39 0173 81371 – [www.agribarberis.it](http://www.agribarberis.it)
- ore 12:30** Pranzo all'Osteria da Gemma  
Via Marconi 6 – 12050 Roddino  
tel +39 0173 794252 – [www.osteriadagemma.it](http://www.osteriadagemma.it)
- ore 14:30** Rientro ad Alba via Dogliani
- ore 17:30** Arrivo in Hotel e visita libera al Mercato del Tartufo  
presso il Cortile della Maddalena in Centro ad Alba
- ore 20:30** Cena presso il ristorante Panoramico dell'Hotel I Castelli

## Domenica 5 Novembre

- ore 09:30** Partenza per la visita alle Cantine Bosca  
Via Giovanni Battista Giuliani 23 – 14053 Canelli  
tel +39 0141 967711 – [www.bosca.it](http://www.bosca.it)
- ore 12:30** Pranzo all'Osteria La Casa nel Bosco  
Regione Galvagno – 14050 Cassinasco  
tel +39 0141 851305 – [www.casanelbosco.com](http://www.casanelbosco.com)



*Claudio Mosconi*

*+41 79 825 34 12*

*Marcello Grigorov*

*+39 347 947 44 71*

















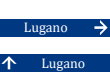







*Giancarlo Vassetta*

*+39 339 856 14 74*

## Elenco Iscritti - Teilnehmerliste

#	Conduttore		Navigatore		Vettura	Anno	Naz
1	Giancarlo	Vassetta	--	--	--		I
2	René	Widmer	--	--	Gransport	2012	CH
3	Patrick	Müller	Nicole	Sardella	S Q 4	2016	CH
4	Philippe	Guiot	Jasminka	Guiot	Mexico	1966	F
5	Roberto	Mosconi	Sara	Proverbio	Merak SS	1980	CH
6	Pompeo	D'Ingiandi	Sabrina	Dikkaya	Gran Turismo S	2013	CH
7	Carlotta	Wenger-Pfenninger	Heini	Pfenninger	Quattroporte S	2016	CH
8	Biagio	Pompa	Claudia	Pompa	Quattroporte	2014	CH
9	Claudio	Vidoli	Massimo	Pelloni	Ghibli	1966	CH
10	Luca	Spampinato	Sabrina	Capasso	3200 GT	2008	I
11	Hans	Schweizer	Jackie	Schweizer	3500 GT	1959	CH
12	Chato	Boffa	Kalinka	Boffa	--		CH
14	Othmar	Aerne	Heidi	Aerne	Shamal	1993	CH
15	Sandro	Falluca	Patrizia	Falluca	4200 Coupé	2004	CH
16	Marcello	Grigorov	Anna	Grigorov	--		CH
18	Rainer	Füchslin	Jeannette	Füchslin-Koops	Quattroporte	2009	CH
19	Rolf	Schiemenz	--	--	430	1966	D
20	Federico	Malaguti	Paolo	Muzzioli	Royale	1987	I
21	Andrea	Montalenti	Emanuela	Montalenti	3500 Touring	1963	I
23	Francois	Schwitter	Micaele	Tavecchio	--		CH
24	Roberto	Tudini	Anna Giulia	Patania	Quattroporte	1980	I
25	Rolf	Renz	Jrene	Renz	3500 GT	1960	CH
26	Claudio	Ivaldi	--	--	3500 Spider	1961	I
28	Claudio	Mosconi	--	--	3500 GT	1961	CH

# LEGENDA

 <p>Direzione da seguire Direction to be followed Richtung folgen Direction à suivre</p>	 <p>Oasi Oasis Oase Oasis</p>	 <p>Semaforo Traffic light Verkehrssampel Feu</p>	
 <p>Direzione da non seguire Direction not to be followed Richtung nicht folgen Direction à ne pas suivre</p>	 <p>Parking Parking Parking Parking</p>	 <p>Attenzione / Pericolo Attention / Danger Achtung / Gefahr Attention / Danger</p>	
 <p>Direzione da seguire Direction to be followed Richtung folgen Direction à suivre</p>	 <p>Rispondere alle domande Answer the questions Fragen beantworten Repondre aux questions</p>	 <p>STOP !</p>	
 <p>Direzione da non seguire Direction not to be followed Richtung nicht folgen Direction à ne pas suivre</p>	 <p>Torrente - Fiume Stream - River Strom - Fluss Torrent - Rivière</p>	 <p>Dare la precedenza Give way Vorfahrt bechten Donner la priorité</p>	
<p>P.A.</p> <p>Prova di abilità Ability test Geschicklichkeitsprüfung Epreuve d'adresse</p>	 <p>Paesaggio magnifico ! Exciting landscape ! Schöne Aussicht ! Panorama épatant !</p>	 <p>Direzione obbligatoria Obligatory direction Richtung obligatorisch Direction obligatoire</p>	
<p>P.P.</p> <p>Prova di precisione Precision test Präzisionsprüfung Epreuve de precision</p>	 <p>Guardarsi bene intorno ! Watch around carefully Sehen Sie sich gut um Bien observer alentour !</p>	 <p>Senso unico One way Einbahn Sense unique</p>	
<p>C.O.</p> <p>Controllo orario Time control Zeitkontrolle Contrôle horaire</p>	 <p>Accostare Approach the side Auf der Seite abstellen Garez la voiture</p>	 <p>Doppio senso di marcia Double way Gegenverkehr Circulation deux sens</p>	
<p>C.T.</p> <p>Controllo a timbro Rubber stamping control Stempelkontrolle Control a timbre</p>	 <p>Area di Servizio Gas station Tankstelle Pompe à essence</p>	 <p>Nome della località Name of the place Ortsname Nom de l'endroit</p>	
 <p>Costruzioni Buildings Bauten Bâtiments</p>	 <p>Ponte Bridge Brücke Pont</p>	 <p>Gimkana Cono Mark hat Kegel Gimkhana Quille</p>	 <p>Barriera Barrier Barrier Barrière</p>

km  
parziale  
partial  
partiele-partiel





km  
totale  
total  
gesamt-totale

mg

percorso  
way - Richtung - parcours

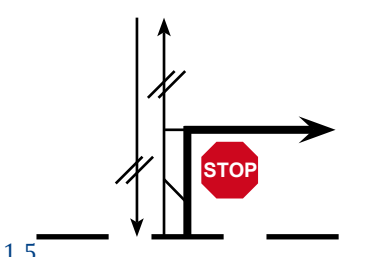
annotazioni  
notes - Anmerkungen - notes

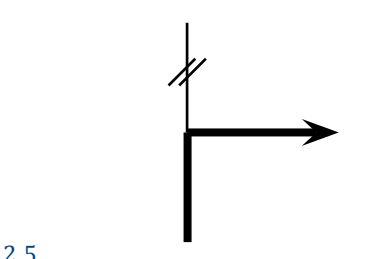
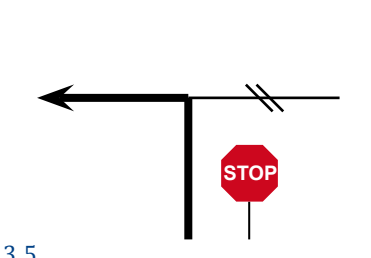
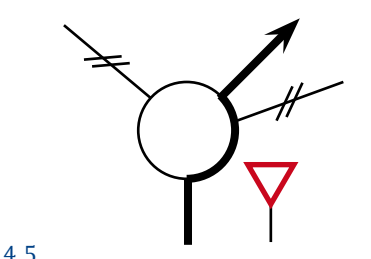
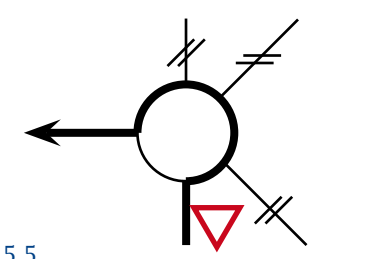
km all'arrivo  
at arrival  
bei der Ankunft  
à l'arrivée

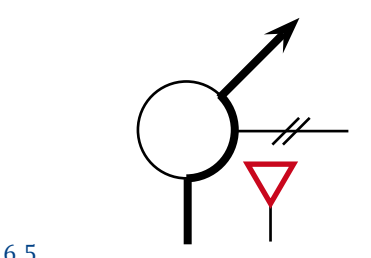
A	0,0			65,2
0,1	0,1			65,1
0,2	0,3			64,9
0,1	0,4			64,8
0,7	1,1			64,1
0,4	1,5			63,7

km  
parziale  
partial  
partiele-partiel





km  
totale  
total  
gesamt-totale

percorso  
way - Richtung - parcours

annotazioni  
notes - Anmerkungen - notes

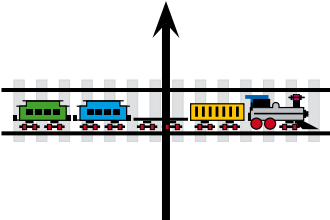
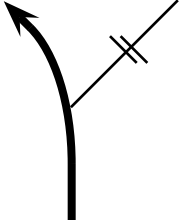
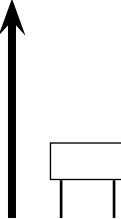
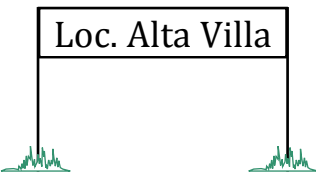
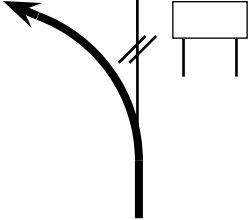
km all'arrivo  
at arrival  
bei der Ankunft  
à l'arrivée

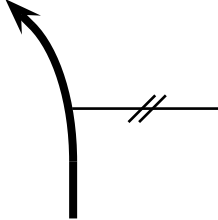
mg

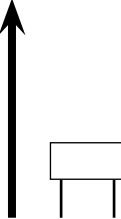
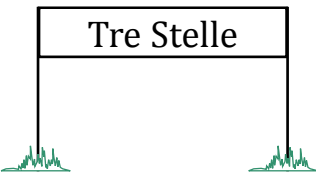
0,1	1,6	 1 6		63,6
0,1	1,7	 2 6		63,5
1,2	2,9	 3 6		62,3
0,9	3,8	 4 6		61,4
1,0	4,8	 5 6		60,4
3,0	7,8	 6 6		57,4







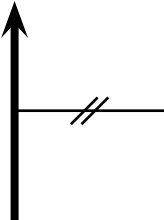

km  
parziale  
partial  
partiele-partiel

km  
totale  
total  
gesamt-totale

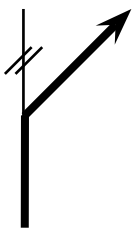
percorso  
way - Richtung - parcours

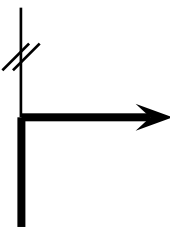
annotazioni  
notes - Anmerkungen - notes

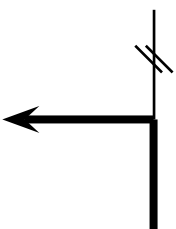
km all'arrivo  
at arrival  
bei der Ankunft  
à l'arrivée

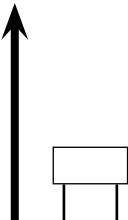
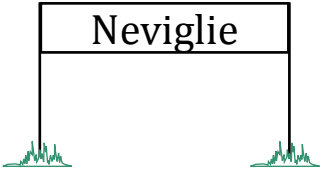
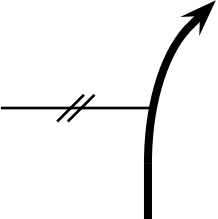
0,1	7,9			57,3
		1 7		
0,2	8,1			57,1
		2 7		
1,8	9,9			55,3
		3 7		
2,4	12,3			52,9
		4 7		
1,3	13,6			51,6
		5 7		
0,4	14,0			51,2
		6 7		

km  
parziale  
partial  
partiele-partiel







km  
totale  
total  
gesamt-totale

percorso  
way - Richtung - parcours

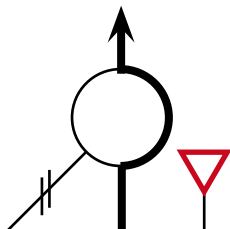
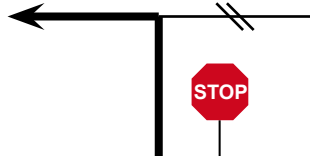
annotazioni  
notes - Anmerkungen - notes

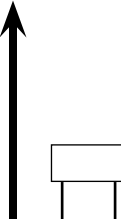
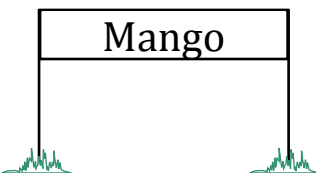
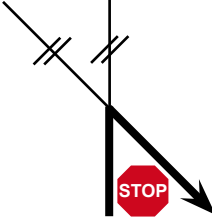
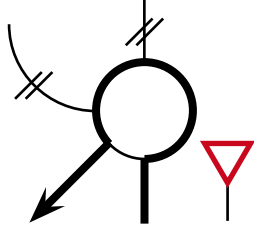
km all'arrivo  
at arrival  
bei der Ankunft  
à l'arrivée

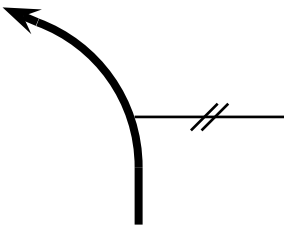
mg

0,1	14,1	 1 8		51,1
2,5	16,6	 2 8		48,6
0,3	16,9	 3 8		48,3
0,9	17,8	 4 8		47,4
0,1	17,9	 5 8		47,3
1,6	19,5	 6 8		45,7



km  
parziale  
partial  
partiele-partiel

km  
totale  
total  
gesamt-totale

percorso  
way - Richtung - parcours

annotazioni  
notes - Anmerkungen - notes

km all'arrivo  
at arrival  
bei der Ankunft  
à l'arrivée

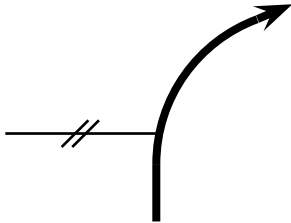
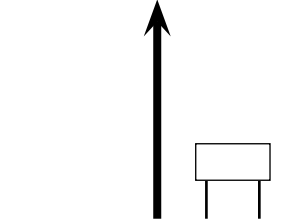
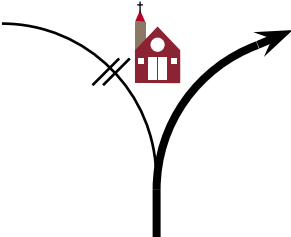
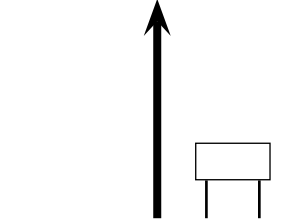
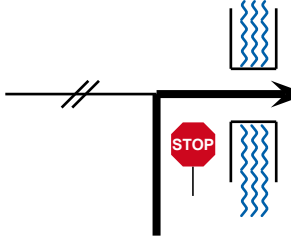
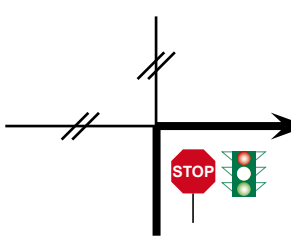
1,5	21,0	 <p>1 9</p>	<p>S. Stefano Belbo →</p> <p>Valdivilla →</p>	44,2
0,7	21,7	 <p>2 9</p>	<p>Valdivilla</p>	43,5
1,1	22,8	 <p>3 9</p>	<p>San Maurizio →</p> <p>S. Stefano Belbo →</p>	42,4
5,5	28,3	 <p>4 9</p>	<p>S. Stefano Belbo</p>	36,9
0,6	28,9	 <p>5 9</p>	<p>Nizza Monferrato →</p> <p>Canelli →</p>	36,3
0,3	29,2	 <p>6 9</p>	<p>Cossano Belbo →</p>	36,0

km  
parziale  
partial  
partie-partiel







km  
totale  
total  
gesamt-totale

percorso  
way - Richtung - parcours

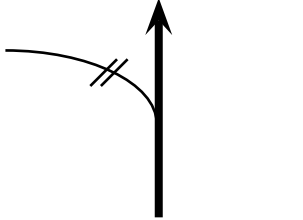
annotazioni  
notes - Anmerkungen - notes

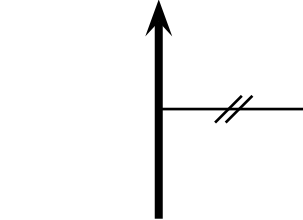
km all'arrivo  
at arrival  
bei der Ankunft  
à l'arrivée

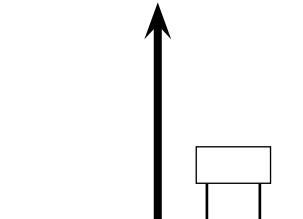
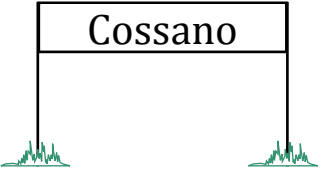
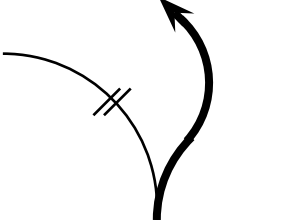
mg

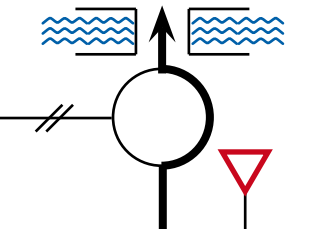
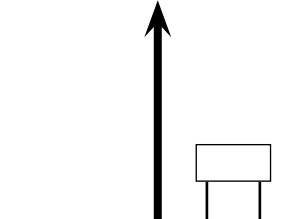
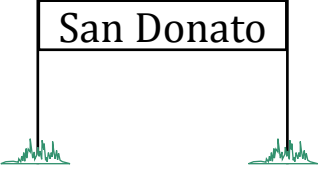
1,0	30,2	 1 10		35,0
1,0	31,2	 2 10		34,0
2,8	34,0	 3 10		31,2
0,6	34,6	 4 10		30,6
0,4	35,0	 5 10		30,2
6,1	41,1	 6 10		24,1







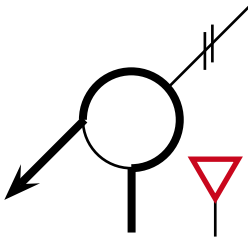

km  
parziale  
partial  
partiele-partiel

km  
totale  
total  
gesamt-totale

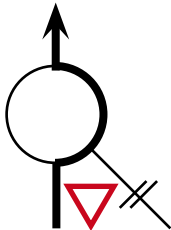
percorso  
way - Richtung - parcours

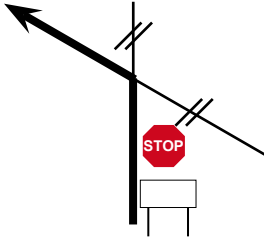
annotazioni  
notes - Anmerkungen - notes

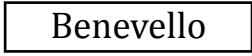
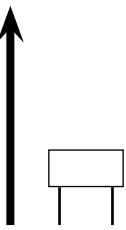
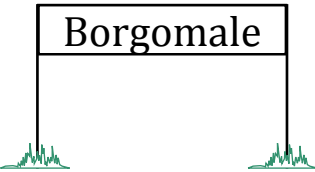
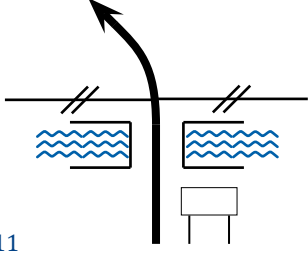
km all'arrivo  
at arrival  
bei der Ankunft  
à l'arrivée

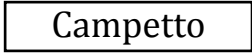
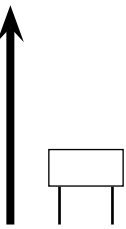
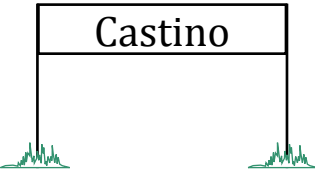
1,9	43,0	 <p>1 11</p>		22,2
4,0	47,0	 <p>2 11</p>		18,2
2,5	49,5	 <p>3 11</p>	 	15,7
3,4	52,9	 <p>4 11</p>		12,3
2,7	55,6	 <p>5 11</p>	 	9,6
3,2	58,8	 <p>6 11</p>		6,4

km  
parziale  
partial  
partiele-partiel



km  
totale  
total  
gesamt-totale

percorso  
way - Richtung - parcours

annotazioni  
notes - Anmerkungen - notes

km all'arrivo  
at arrival  
bei der Ankunft  
à l'arrivée

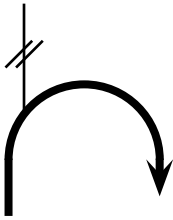
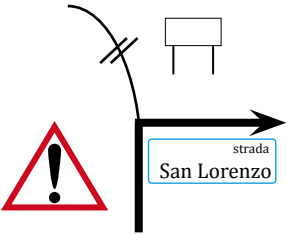
mg

5,4	64,2		<div style="background-color: #0056b3; color: white; padding: 5px; display: inline-block;">             Savona Cortemilia             <span style="font-size: 2em; vertical-align: middle;">➔</span> </div>	1,0
		1 12		
1,0	65,2		<div style="border: 1px solid black; padding: 5px; display: inline-block;">             Cortemilia         </div> 	0,0
		2 12		









km  
parziale  
partial  
partiele-partiel

km  
totale  
total  
gesamt-totale

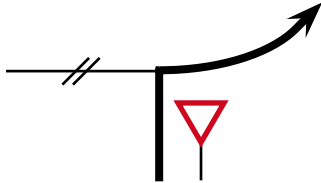
percorso  
way - Richtung - parcours

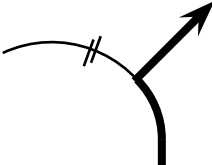
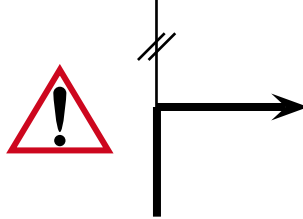
annotazioni  
notes - Anmerkungen - notes

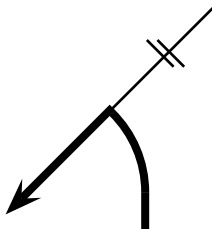
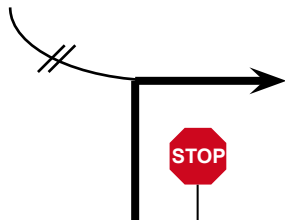
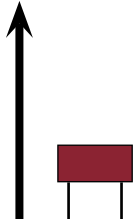
km all'arrivo  
at arrival  
bei der Ankunft  
à l'arrivée

<p><b>B</b></p>	<p>0,0</p>	<p>1 13</p> 	 <p>↓</p> <p>osteria <i>da Gemma</i></p>	<p>26,9</p>
<p>1,2</p>	<p>1,2</p>	<p>2 13</p> 	<p>Millesimo →</p>	<p>25,7</p>
<p>6,8</p>	<p>8,0</p>	<p>3 13</p> 	<p>AZIENDA VITIVINICOLA <b>CANONICA</b> →</p> <p>piscina comunale BAR  →</p>	<p>18,9</p>
<p>0,6</p>	<p>8,6</p>	<p>4 13</p> 		<p>18,3</p>
<p>0,2</p>	<p>8,8</p>	<p>5 13</p> 		<p>18,1</p>
<p>3,3</p>	<p>12,1</p>	<p>6 13</p> 		<p>14,8</p>

km  
parziale  
partial  
partiele-partiel

km  
totale  
total  
gesamt-totale

percorso  
way - Richtung - parcours

annotazioni  
notes - Anmerkungen - notes

km all'arrivo  
at arrival  
bei der Ankunft  
à l'arrivée

mg

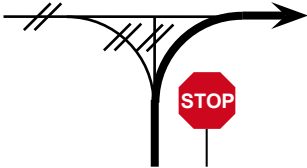
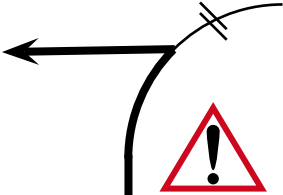
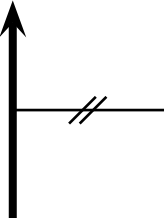
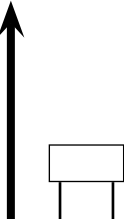
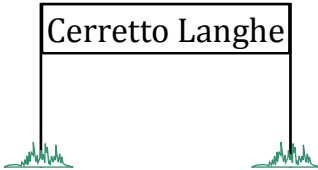
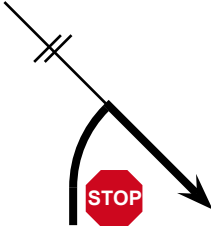
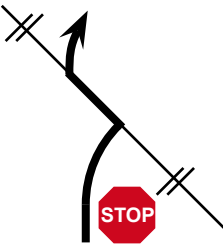
0,4	12,5	 <p>1 14</p>	<p>Alba →</p>	14,4
0,1	12,6	 <p>2 14</p>	<p>← Cerretto L.</p>	14,3
1,7	14,3	 <p>3 14</p>	<p>← Cerretto L.</p>	12,6
3,8	18,1	 <p>4 14</p>		8,8
0,8	18,9	 <p>5 14</p>		8,0
2,1	21,0	 <p>6 14</p>	<p>Monforte → Serralunga → Sinio → Roddino →</p>	5,9







km  
parziale  
partial  
partiele-partiel

km  
totale  
total  
gesamt-totale

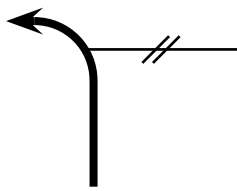
percorso  
way - Richtung - parcours

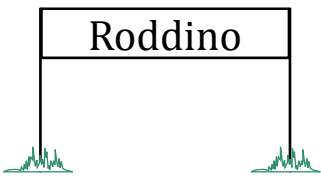
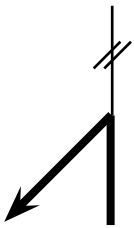
annotazioni  
notes - Anmerkungen - notes

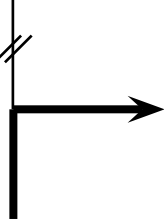
km all'arrivo  
at arrival  
bei der Ankunft  
à l'arrivée

2,1	23,1			3,8
		1 15		
3,1	26,2			0,7
		2 15		
0,4	26,6	 		0,3
		3 15		
0,3	26,9			0,0
		4 15		

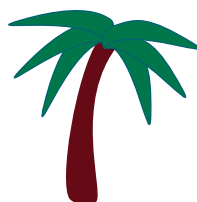

osteria  
da Gemma

km  
parziale  
partial  
partiele-partiel









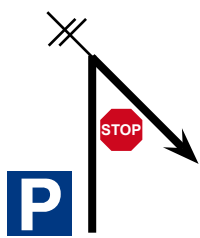

km  
totale  
total  
gesamt-totale

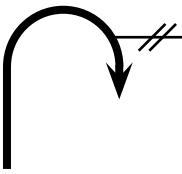
percorso  
way - Richtung - parcours

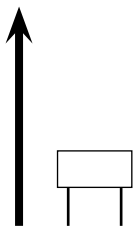
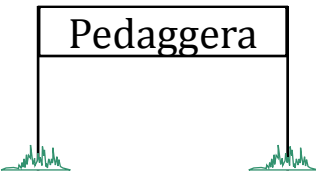
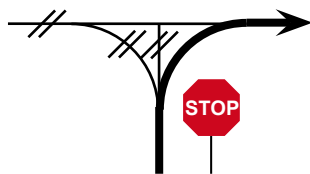
annotazioni  
notes - Anmerkungen - notes

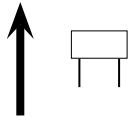
km all'arrivo  
at arrival  
bei der Ankunft  
à l'arrivée

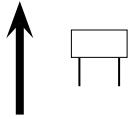
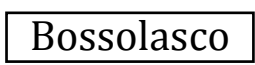
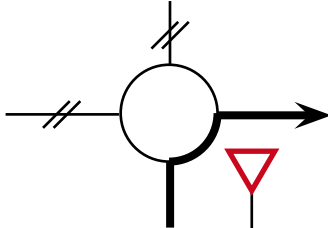
mg

C	0,0	 1 16	<p>osteria <i>da Gemma</i></p> 	48,3
3,3	3,3	 2 16		45,0
2,0	5,3	 3 16		43,0
0,2	5,5	 4 16		42,8
1,5	7,0			41,3
3,7	10,7	 5 16		37,6
1,0	11,7	 6 16		36,6









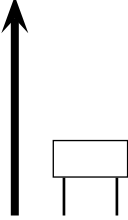
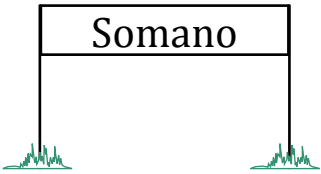
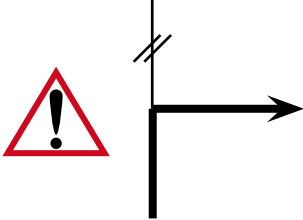

km  
parziale  
partial  
partiele-partiel

km  
totale  
total  
gesamt-totale

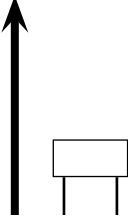
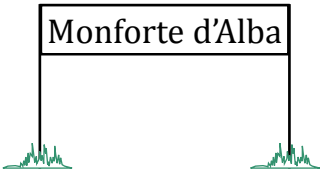
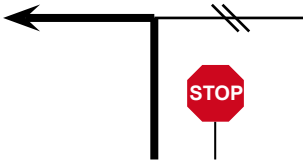
percorso  
way - Richtung - parcours

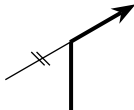
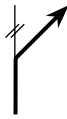
annotazioni  
notes - Anmerkungen - notes

km all'arrivo  
at arrival  
bei der Ankunft  
à l'arrivée

3,5	15,2	1 17 		33,1
6,9	22,1	2 17 		26,2
6,1	28,2	3 17 		20,1
0,5	28,7	4 17 		19,6
0,2	28,9			19,4
0,1	29,0	5 17 		19,3
19,3	48,3	6 17 		0,0

km  
parziale  
partial  
partiele-partiel









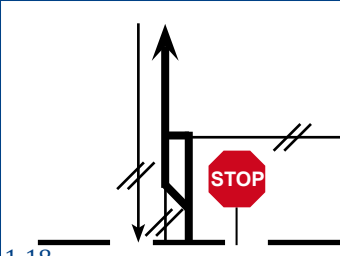

km  
totale  
total  
gesamt-totale

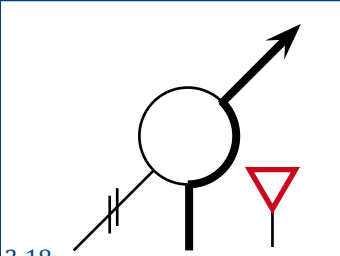
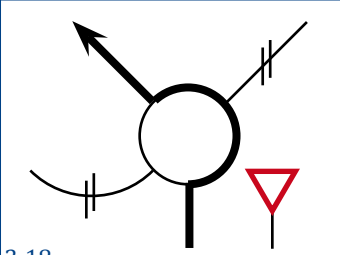
percorso  
way - Richtung - parcours

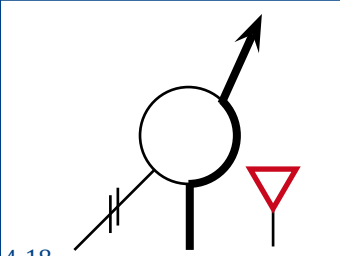
annotazioni  
notes - Anmerkungen - notes

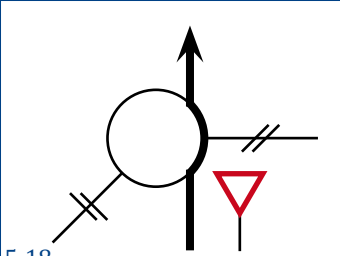
km all'arrivo  
at arrival  
bei der Ankunft  
à l'arrivée

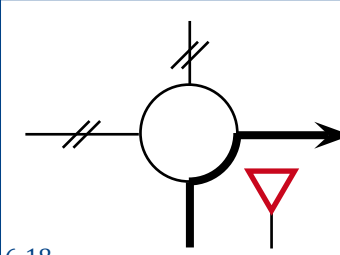
mg

D	0,0	 1 18		37,2
0,1	0,1	 2 18		37,1
0,5	0,6	 3 18		36,6
1,1	1,7	 4 18		35,5
0,1	1,8	 5 18		35,4
0,5	2,3	 6 18		34,9

km  
parziale  
partial  
partiele-partiel







km  
totale  
total  
gesamt-totale

mg

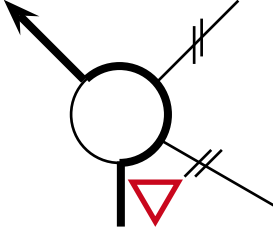
percorso  
way - Richtung - parcours

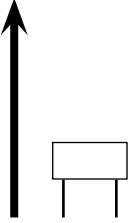
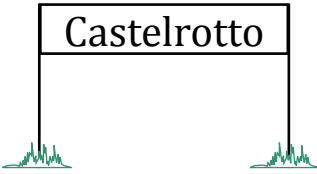
annotazioni  
notes - Anmerkungen - notes

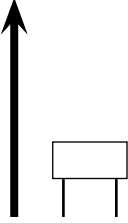
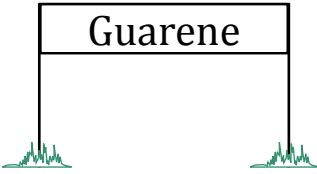
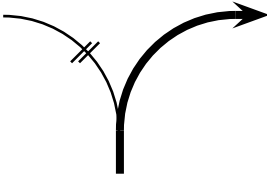
km all'arrivo  
at arrival  
bei der Ankunft  
à l'arrivée

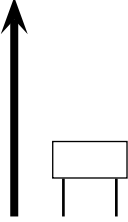
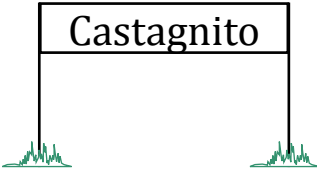
0,2	2,5			34,7
		1 19		
0,8	3,3			33,9
		2 19		
1,2	4,5			32,7
		3 19		
0,4	4,9			32,3
		4 19		
1,1	6,0			31,2
		5 19		
1,3	7,3			29,9
		6 19		

km  
parziale  
partial  
partiele-partiel











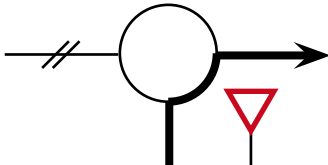

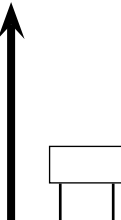

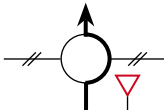
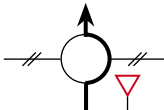
km  
totale  
total  
gesamt-totale

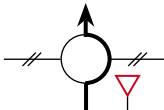
percorso  
way - Richtung - parcours

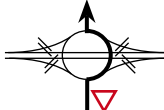
annotazioni  
notes - Anmerkungen - notes

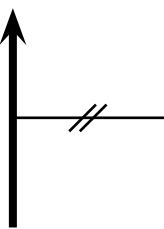
km all'arrivo  
at arrival  
bei der Ankunft  
à l'arrivée

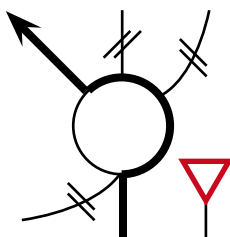
mg

0,6	7,9	 1 20		29,3
1,4	9,3	 2 20		27,9
1,2	10,5			26,7
0,7	11,2	 3 20		26,0
0,6	11,8			25,4
0,4	12,2	 4 20		25,0
2,8	15,0	 5 20		22,2
1,9	16,9	 6 20		20,3







km  
parziale  
partial  
partiele-partiel



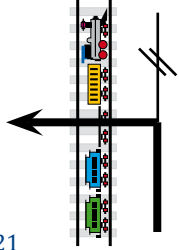
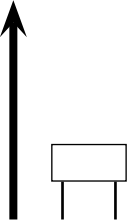
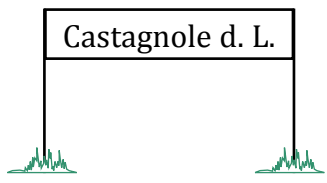
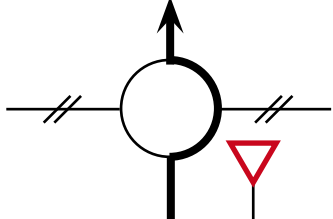

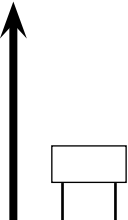
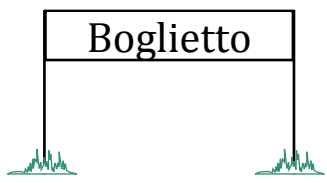
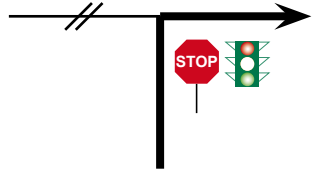
km  
totale  
total  
gesamt-totale

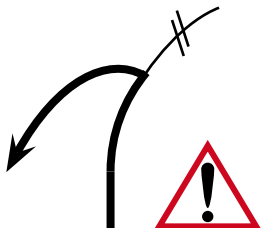
percorso  
way - Richtung - parcours

annotazioni  
notes - Anmerkungen - notes

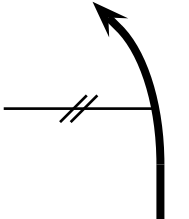
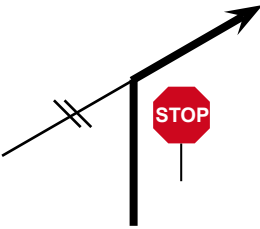
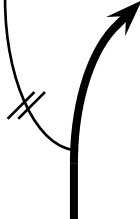
km all'arrivo  
at arrival  
bei der Ankunft  
à l'arrivée

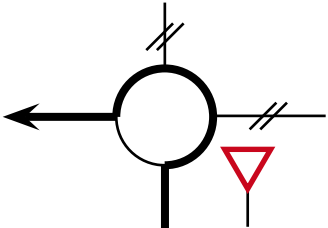
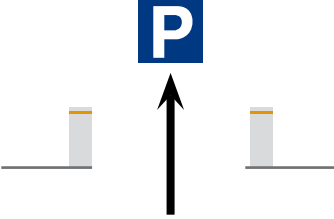
1,0	17,9	 <p>1 21</p>		19,3
3,0	20,9	 <p>2 21</p>		16,3
1,1	22,0	 <p>3 21</p>		15,2
3,5	25,5	 <p>4 21</p>		11,7
1,0	26,5	 <p>5 21</p>		10,7
6,0	32,5	 <p>6 21</p>		4,7

km parziale partial partiele-partiel	km totale total gesamt-totale	percorso way - Richtung - parcours	annotazioni notes - Anmerkungen - notes	km all'arrivo at arrival bei der Ankunft à l'arrivée	mg
1,1	33,6	 1 22		3,6	
0,2	33,8	 2 22		3,4	
2,0	35,8	 3 22		1,4	
1,3	37,1	 4 22		0,1	
0,1	37,2	 5 22		0,0	









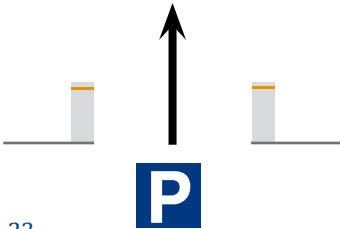

km  
parziale  
partial  
partiele-partiel

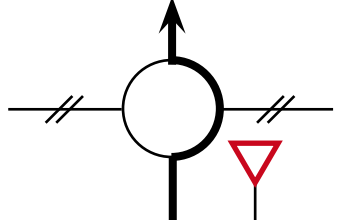
km  
totale  
total  
gesamt-totale

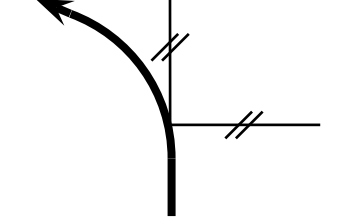
percorso  
way - Richtung - parcours

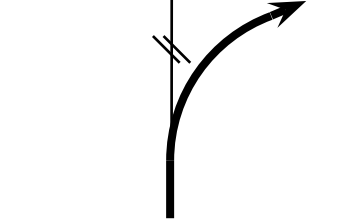
annotazioni  
notes - Anmerkungen - notes

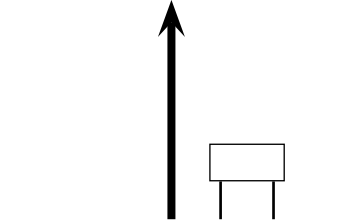
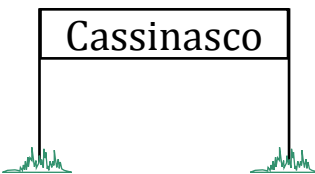
km all'arrivo  
at arrival  
bei der Ankunft  
à l'arrivée

E	0,0	 <p>1 23</p>		5,9
0,1	0,1	 <p>2 23</p>		5,8
0,2	0,3	 <p>3 23</p>		5,6
0,1	0,4	 <p>4 23</p>		5,5
3,8	4,2	 <p>5 23</p>		1,7
0,5	4,7	 <p>6 23</p>		1,2

km  
parziale  
partial  
partiele-partiel







km  
totale  
total  
gesamt-totale

percorso  
way - Richtung - parcours

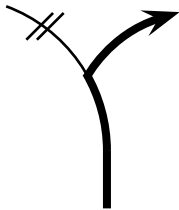
annotazioni  
notes - Anmerkungen - notes

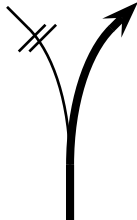
km all'arrivo  
at arrival  
bei der Ankunft  
à l'arrivée

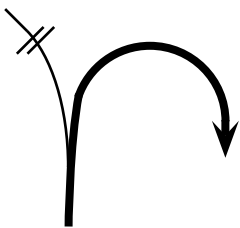
mg

0,7	5,4	 <p>1 24</p>	 <p>RISTORANTE →</p> <p>Monastero Bormida →</p>	0,5
0,4	5,8	 <p>2 24</p>	 <p>RISTORANTE →</p> <p>Monastero Bormida →</p>	0,1
0,1	5,9	 <p>3 24</p>	 <p>RISTORANTE →</p>	0,0

